

PLAN VIEW DETAIL OF CUSTOM
CANTILEVER AIRFOIL SUNSHADE SYSTEM

WALL CONDITION
IS ASSUMED

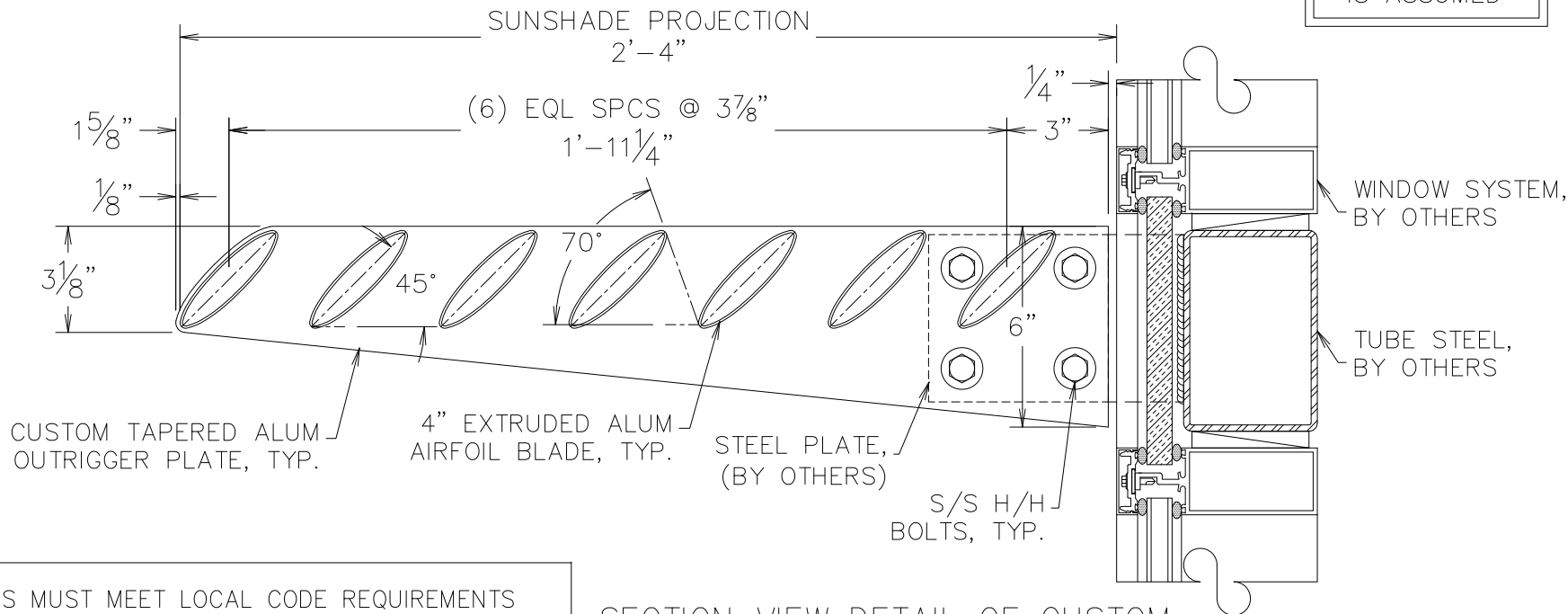

SECTION VIEW DETAIL OF CUSTOM
CANTILEVER AIRFOIL SUNSHADE SYSTEM 100-3C-5

SUNSHADE DESIGNS MUST MEET LOCAL CODE REQUIREMENTS
PLEASE CONTACT C/S REPRESENTATIVE IN YOUR AREA
FOR ASSISTANCE.

THIS DOCUMENT IS THE PROPERTY OF CONSTRUCTION SPECIALTIES, INC., WHICH CONTAINS CONFIDENTIAL PROPRIETARY INFORMATION THAT IS NOT TO BE DISCLOSED TO A THIRD PARTIES, AND IS NOT TO BE USED WITHOUT WRITTEN APPROVAL FROM CONSTRUCTION SPECIALTIES, INC.



Construction Specialties™

49 Meeker Avenue, Cranford, NJ 07016-3198
Phone (800)-526-6930 / Fax (908)-272-6038

PROJECT:	SCALE: 3/16" = 1"
LOCATION:	DSGN & DRW BY: MENA MORCOS
ARCH'S:	DATE:
AGENT:	DRW NO : 1