

6" OPERATING LOUVERS – MODEL 6945 (EX-170)

LOUVER FURNISHED WITH 1i"x1i"xe" ALUM.
 CLIP ANGLES 24" O.C. (JAMBS ONLY) (MIN. 2 PER JAMB)
 PERIMETER MOUNTING HARDWARE NOT BY C/S.

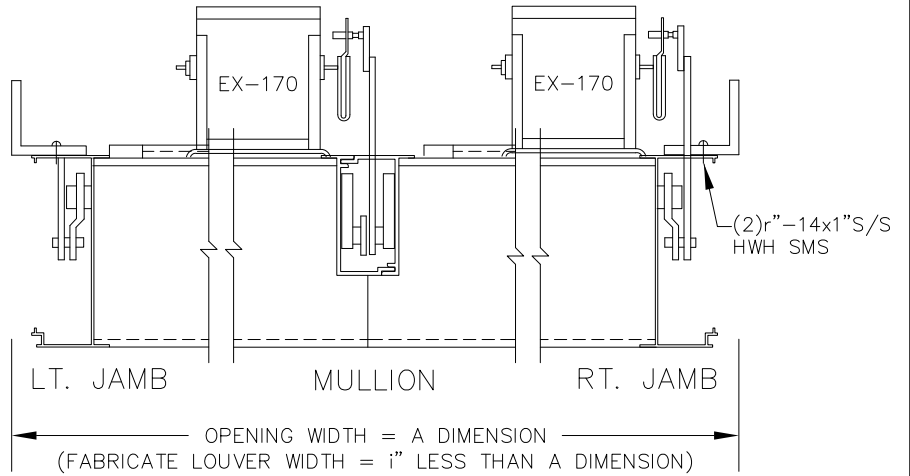
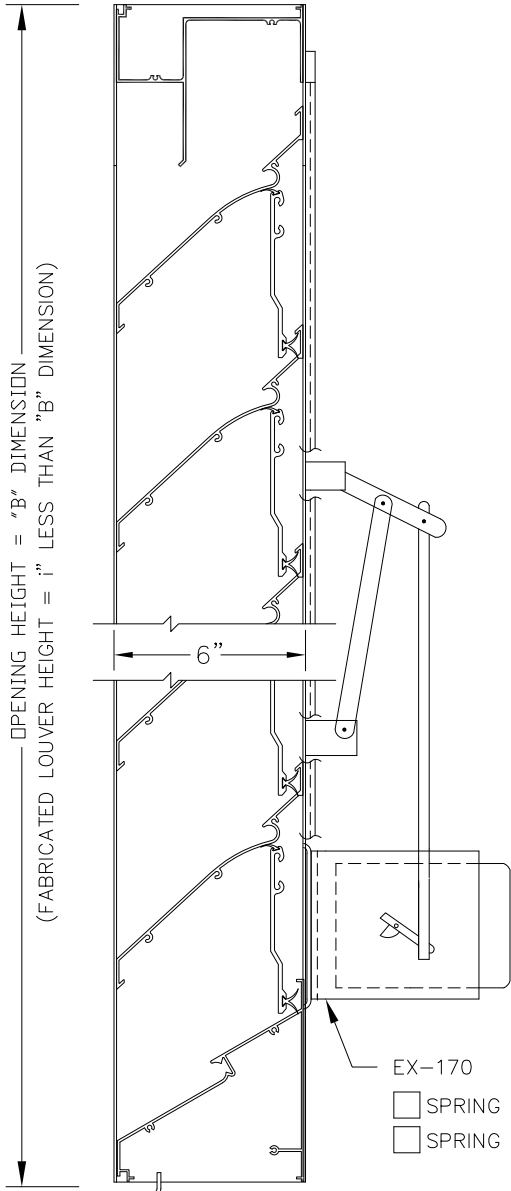

SCREENS

- SCREEN NOT REQUIRED
- SCREEN REQUIRED
- INTERIOR MOUNTED
- EXTERIOR MOUNTED
- BIRDSCREEN (1/2" MESH)
- INSECT SCREEN (18x16 MESH)

FINISHES

- STANDARD MILL
- DURACOLOR (400)
- KYNAR (500)
 - (1) OF C/S STD. COLORS
 - CUSTOM COLOR, C/S REQUIRES A COLOR CHIP FOR MATCHING
- ARCHITECTURAL CLASS I (DK. OR MED.) BRONZE ANODIC COATING
- 204-R1 CLEAR ANODIZE
- OTHER _____

SILL EXTENSIONS

- * SETBACK DIM = 0"-3i "
- * SETBACK DIM = 3s"-6"

C/S EXTRUDED ALUMINUM, OPERATING LOUVER MODEL 6945. FRAMES AND BLADES TO BE FABRICATED FROM 6063-T5 ALLOY, WITH REINFORCING BOSSES AND A NOMINAL OF .080" MATERIAL THICKNESS. OPERATING BLADE TO BE .125" MATERIAL THICKNESS ALL FASTENERS TO BE STAINLESS STEEL.

UNSUPPORTED BLADE LENGTH= @ PSF.

MARK	QTY.	"A" DIM.	"B" DIM.	NUMBER OF MULLIONS	OPERATOR LOCATION	LOCATION	REMARKS
							CKD. BY:

Construction Specialties, Inc.
 49 Meeker Avenue
 Cranford, New Jersey 07016
 (908) 272-5200
 Fax (908) 272-6038

PROJECT:	DRAWN BY:
CUSTOMER:	DATE:
ARCH'T:	DWG. NO:
AGENT:	SHEET OF