

**ARCHITECT NOTE:**

PLEASE SELECT, SEAL COLOR DESIRED,  
FROM THE COLORS LISTED BELOW

108 BLACK		270 GREIGE	
136 GRAY		232 WHITE	

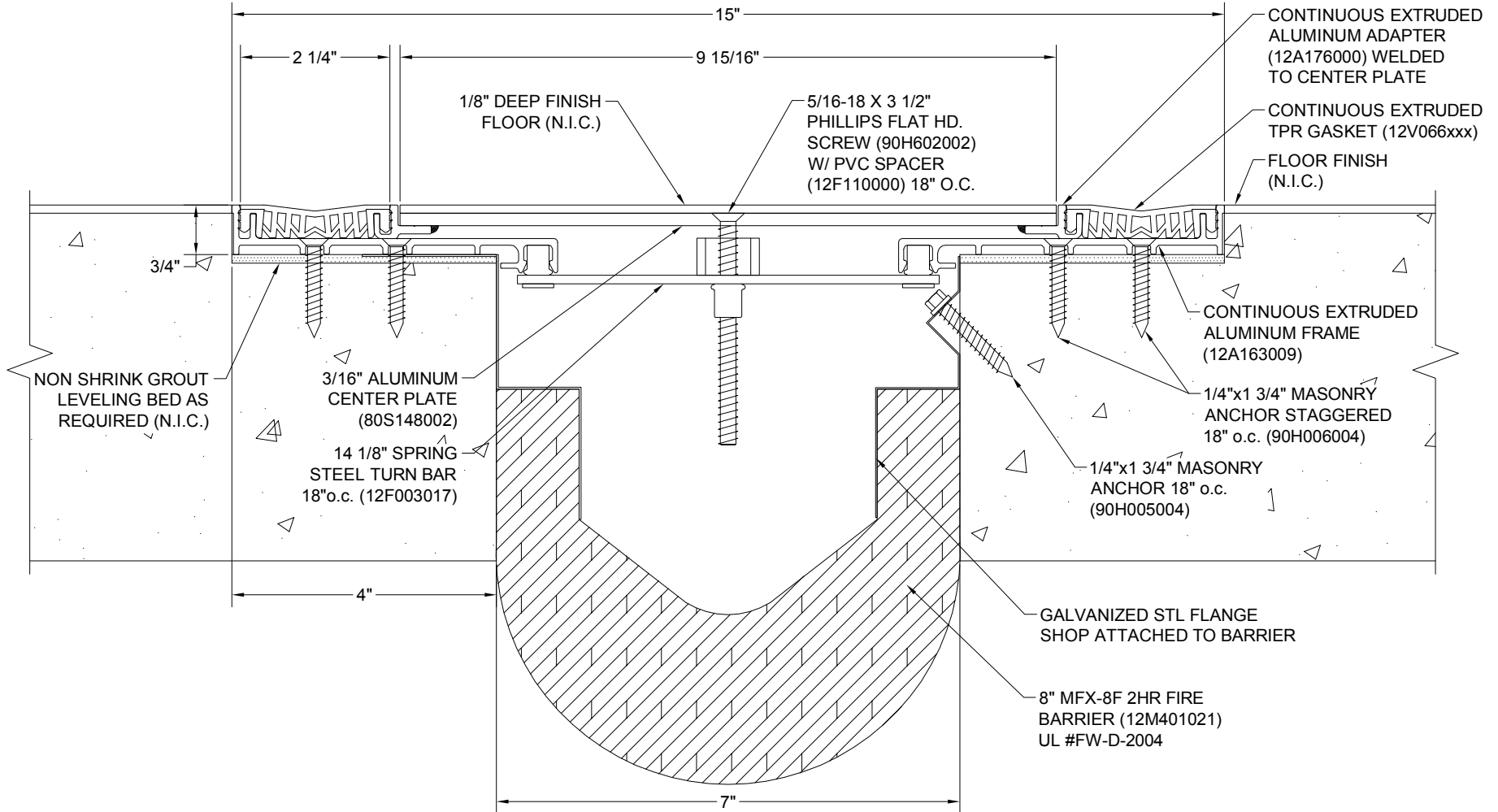

**SGR-700 W/ MFX-7F**



**Construction Specialties™**

6696 Route 405 Highway, Muncy, PA 17756  
Phone (800) 233-8493 / Fax (570) 546-8022

<b>PROJECT:</b>	<b>SCALE:</b> SCALED TO FIT
<b>CUSTOMER:</b>	<b>DATE:</b>
<b>LOCATION:</b>	<b>JOB NO.:</b>
<b>DRAWN BY:</b>	<b>SHEET NO.:</b>