

ARCHITECT NOTE:

PLEASE SELECT, GASKET COLOR DESIRED,
FROM THE COLORS LISTED BELOW.

108 BLACK		270 GREIGE	
136 GRAY		232 WHITE	

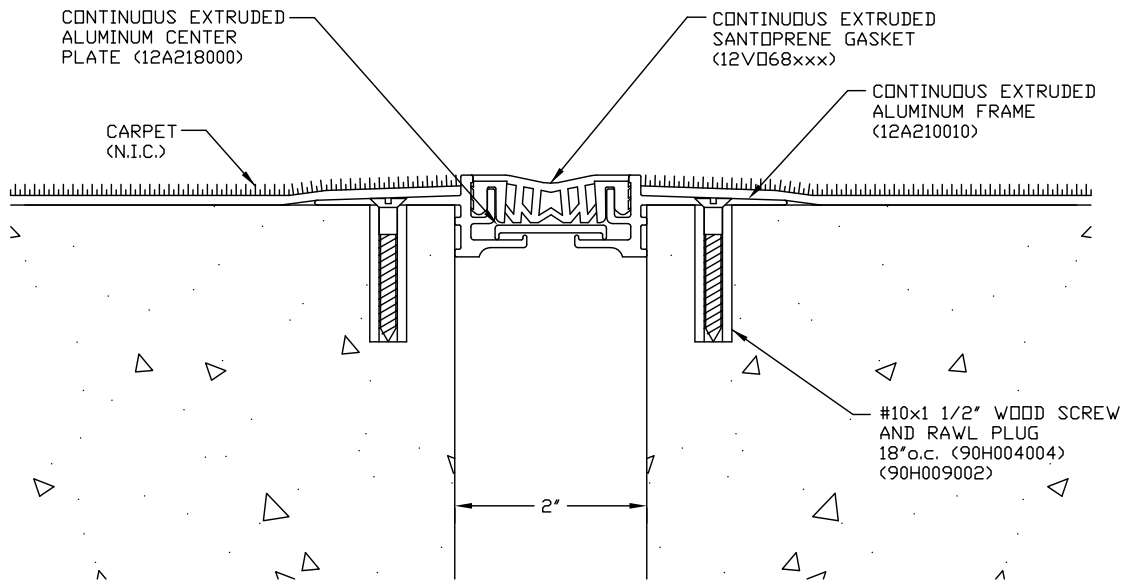

GFPS-200

PROJECT:	SCALE: N.T.S.	DATE:
CUSTOMER:	SUB. BY:	SHT.
LOCATION:	JOB NO:	

C/S Group

Construction Specialties, Inc - C/S Construction Specialties company - Manufacturing / Sales Locations

U.S.A. - Tel:(570) 546-5941/Fax:(570)546-4703/info@c-sgroup.com

Canada - Tel:(905) 274-3611/Fax:(905)274-6241/canada@c-sgroup.com

England - Tel:+44-1-296-611000/Fax:+44-1-296-399444/info@c-sgroup.co.uk

France - Tel:+33-232-648400/Fax:+33-232-648421/export@c-s-france.fr

Singapore - Tel:+65-6-276-4276/Fax:+65-6-273-7557/conspec@singnet.com.sg

Malaysia - Tel:+60-3-556-95227/Fax:+60-3-556-95237/conspec@c-sgroup.com.my

Hong Kong - Tel:+852-2892-0917/Fax:+852-2892-0956/conspec@c-sgroup.com.hk

Taiwan - Tel:+886-2-2712-8120/Fax:+886-2-2713-9022/conspec@c-sgroup.com.tw

Australia - Tel:+61-2-9540-5400/Fax:+61-2-9540-5253/sales@c-sgroup.com.au

New Zealand - Tel:+64-4-527-9156/Fax:+64-4-528-8347/info@c-sgroup.co.nz

U.A.E. - Tel:+971-4-331-2167/Fax:+971-4-331-5023/c_sgroup@emirates.net.ae

Uruguay - Tel:+598-2-525-0126/Fax:+598-2-525-2489/c-sgroup@adinet.com.uy