

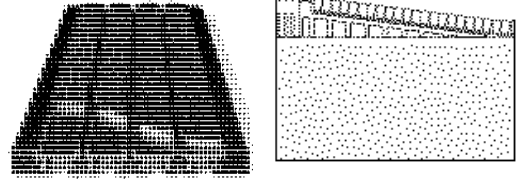

Installation Instructions

Peditred G4 with Pipestem Frame



1). Site Prep

- Clean the floor surface to remove all dirt, oily film, and debris.
- Locate and mark final location in which the Peditred will be placed.

2). Assemble Frame

- The frame pieces have been pre-mitered to allow for quick assembly.
- Remove the protective layer of the tape, which is adhered to the bottom of the frame, and set in its final location.(See Illustration A)

(Note: 3/16" masonry anchors can be used to fasten the frame in high traffic applications)



Illustration A

3. Peditred Installation

Locator Bars are included with the hardware package and must be installed to ensure proper alignment of the Peditred rails.

- Upon final location of the Peditred within the frame, mark the treadrail centerline of the first and second rail on the exposed frame surface at each corner location.

(Illustration B)

- Position the locator bar along the marked line. (Illustration D)
- Using the locator bar as a guide, drill a pilot hole with a 5/32" masonry bit.
- Using a #2 Phillips drive, secure each locator bar with two 3/16" masonry anchors.

(Illustration C)

- Attach two locator bars per corner.

- Install Peditred.

B

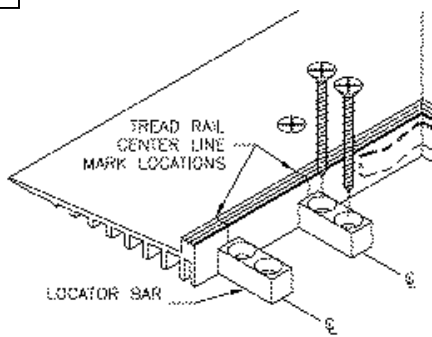

C

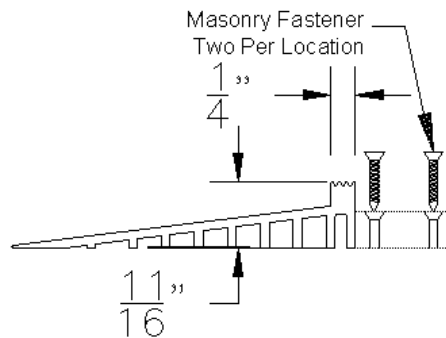

D

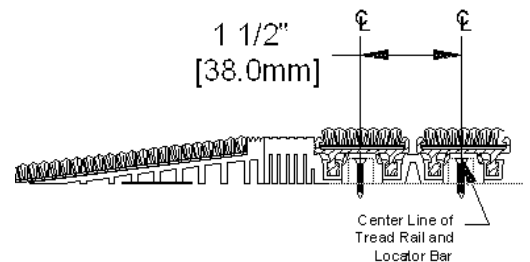

4.) Attaching Modules (If Necessary).

- Attach modules 1,2, and 3 (Illustration E & F) together as shown below utilizing a rubber mallet.
- Depending on the size of the Peditred, there may be multiple modules needed to make one complete unit. These modules must be joined together as shown in (Illustration E)

Illustration E

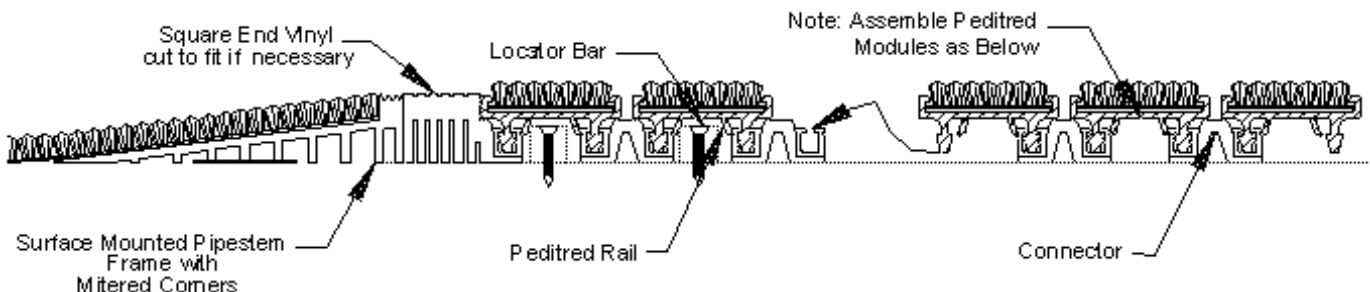

5.) Splice Connections for Large Grids Over 144" Wide

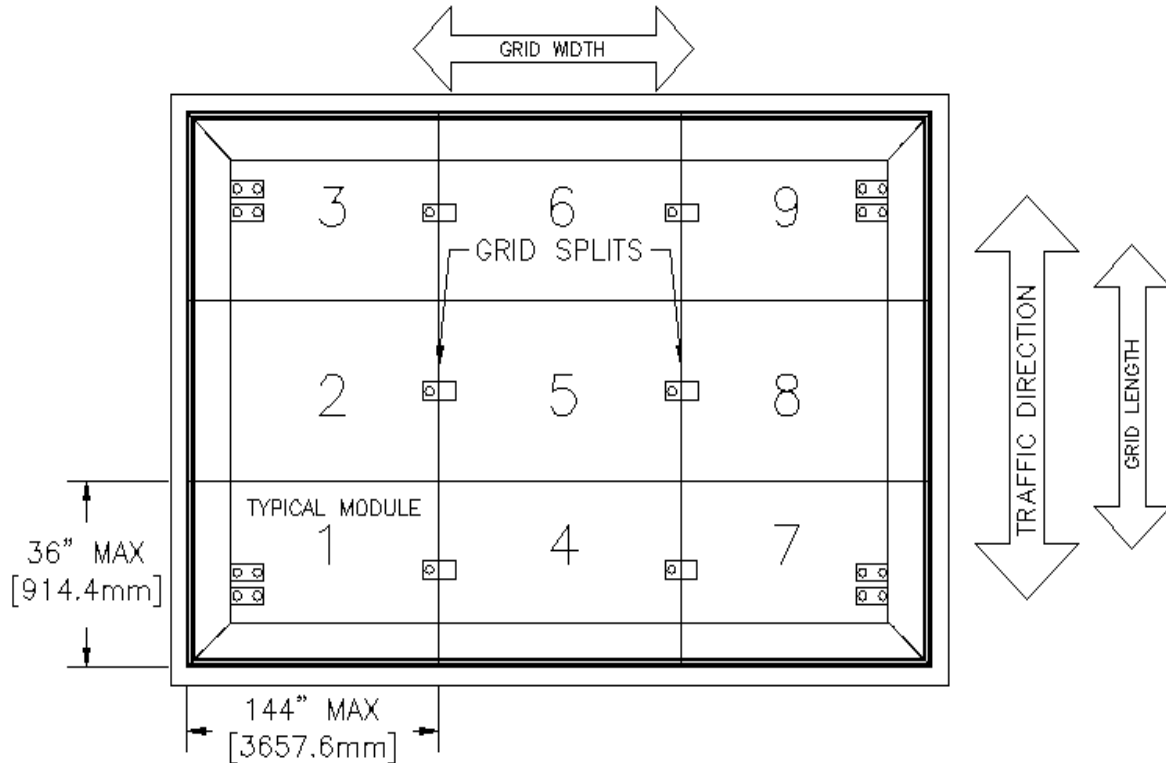

Illustration F

- Trial fit assembly into frame area. Trim end vinyl as required with a utility knife for proper fit.
- Align and secure center tread rail with locator bar.

(Illustration G)

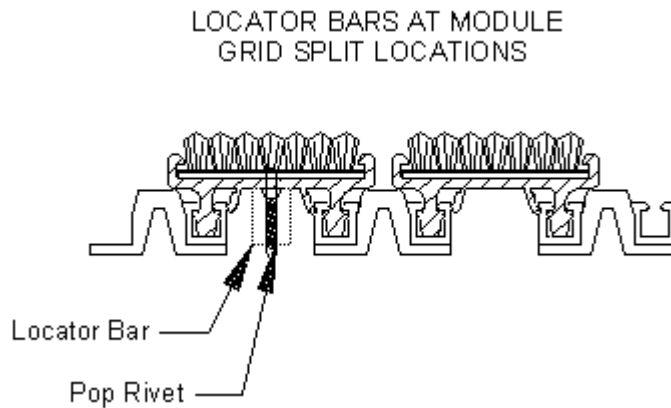

Illustration G

FAQ on this step

Q: Why is my Peditred larger or smaller than the opening between the frames?

A: The vinyl carriers on the underside of the Peditred may expand or contract during shipping. If the Peditred is smaller than the opening, simply roll up and unroll the grid. This will stretch the carriers and allow it to expand. If the Peditred is larger, tuck the end vinyl into the recess and compress the rails flat. End vinyl may need to be trimmed.

6.) Completion

It is necessary to cover the installation with 3/4" plywood until all additional project work is completed. This will protect the Peditred from potential abuse during the construction phase. Damage occurring from inadequate protection during this phase may void the manufacturer's warranty.

7.) Cleaning and Maintenance Instructions for Pedisystems Products.

- **Manufacturer's suggested safe rolling load for the Peditred G4 is 1000# per wheel**
- **Heavy loads beyond this weight may damage the units, contributing to their premature failure or creating a tripping hazard.**
- **Vacuum surface regularly with beater brush attachment to allow contact with various surfaces of entrance flooring.**
- **Before deep cleaning the surface, roll unit back to remove dirt collected underneath as needed. Dirt should be removed with professional vacuum cleaner and should not be allowed to build up to the point where a level mat surface is affected.**
- **Deep clean quarterly, either by removing unit to an area where it can be cleaned with a powerwasher (on light setting to avoid carpet damage) or..**
- **Shampoo the unit in place (soap/water extraction)**
 - **It is recommended that shampooing take place overnight to allow carpet fibers to dry thoroughly before heavy traffic resumes.**
 - **Suggestions for pre-treating the area prior to shampooing**
 - **Remove gum or other sticky substance by applying a commercial freeze spray to the affected area. This should allow the residue to break off easily.**
 - **For ground-in dirt showing in high traffic areas, add one cup of bleach per gallon of warm water and use stiff brush to pre-treat carpet fibers.**
 - **If aluminum needs cleaned, use stiff nylon bristle brush to clean with shampoo mixture prior to shampooing entire unit.**
 - **To achieve the most effective suction of the shampooer, run the wand perpendicular to the rails and not along the length of the carpet strips.**
- **Take care when mopping surrounding floor area. Keep mop away from mat or grid. The aggressive texture of the carpet inserts may grab lint when the mop comes in contact, potentially causing unsightly lint collection at edges of unit.**

Replacement inserts are available: See www.pedisystems.com or call 1-570-546-5941 for more information and for contact information for your local representative.



Construction Specialties™

www.c-sgroup.com

U.S.A. 800-233-8493

Canada 800-233-8493