

**ATTENTION**

Please read these instructions thoroughly prior to beginning the **ACROVYN WALL COVERING** installation.

This instruction sheet is intended to provide a specific guide to follow for the installation of the **ACROVYN WALL COVERING**. Contained within is the technical information and installation techniques required to complete an efficient, neat, and long-lasting installation.

See "**WALL COVERING**– Supplemental Information" sheet for additional notes and other helpful installation tips.

**INSTALLATION INSTRUCTIONS**

**TOOLS AND EQUIPMENT**

SUPPLIED BY CONTRACTOR

- Chalk line
- 6' – 0" level (or larger)
- Straight edge
- Drop cloth
- Masking tape
- Utility knife
- Water bucket
- Mild detergent
- Caulk gun
- Electric shears
- Spiral saw
- Paint tray & roller (if using primer)

SUPPLIED BY CONSTRUCTION SPECIALITES (CS)

**ALL ITEMS BELOW MUST BE USED TO MAINTAIN WARRANTY**

- 1/8" V-Notch towel
- Acrovyn Interiors Heavy Duty Water Based Mastic Adhesive
- Primer (if required) (coverage: 350-400 ft<sup>2</sup> / gal.)

OPTIONAL KIT INCLUDES (IF PURCHASED SEPERATELY)

- |   |               |
|---|---------------|
| Crain #333 extension roller (95W010000) | Utility knife |
| 1/8" V-Notch trowel                     | Putty knife   |
| Paint tray & roller                     | Scissors      |
|   | Sponge pad    |
|   | Compass       |

**WALL PREPARATION**

Examine all new or existing walls that are to receive Acrovyn wall covering. They must be clean, smooth, dry, and free of any oils or loose paint prior to apply primer.

SPECIFIC CONDITIONS:

New drywall or plaster – New drywall should be taped and sanded smooth. When finished, all surfaces should be wiped clean to remove any dust. New plaster should be allowed to cure a minimum of 30 days.

Particle board or plywood – New particle board or plywood should be smooth and all surfaces should be wiped clean to remove any dust to allow for best adhesion.

Concrete & concrete masonry units – Only .060" thick Acrovyn is suggested for use over concrete and CMU wall because the unevenness of the wall will telegraph through thinner Acrovyn wall covering. All concrete or CMU walls should still be made smooth with a coating of spackling compound or a thin set mortar. **Note: CS strongly suggests that a test area be done to insure desired adhesion is achieved. All adhesive testing is the responsibility of the contractor on site.**

Painted surfaces – Painted surfaces must be tested for adhesion. Apply a 12" x 12" piece of Acrovyn in an inconspicuous area. After allowing the sample to set for 24 hours, remove the test piece and examine the area. If the paint has softened where the adhesive was applied, the paint must be removed or sealed with primer. If the walls are drywall, test over a joint compound location if possible.

Existing wall coverings – When installing over existing materials like wallpaper or vinyl wall covering, the entire surface must be inspected for areas that are not securely bonded to the wall surface. Any loose areas must be removed and repaired as required. The existing wall covering should then be cleaned with a mild detergent and wiped dry. Be certain all cleaned areas are completely dry before proceeding. **Note: CS strongly suggests that a test area be done to insure desired adhesion is achieved. All adhesive testing is the responsibility of the contractor on site.**

Ceramic tile – Only .060" thick Acrovyn is suggested for use over existing ceramic tile. Inspect the bond and surface condition of the tile to be sure it is suitable for sheet installation. If the tile bond and surface is not adequate, scuffing the tile to remove the glossy surface glazing may improve the bond to an adequate level. If the bond is still not adequate, the ceramic tile should be removed and the wall surface repaired as required.

Apply joint compound to eliminate all evidence of the tile joints and then apply primer. Once all surfaces have been made smooth, complete the installation according to the CS installation instructions. **Note: CS strongly suggests that a test area be done to insure desired adhesion is achieved. All adhesive testing is the responsibility of the contractor on site.**

**Note: For all other conditions, CS strongly suggests that a test area be done to insure desired adhesion is achieved. All adhesive testing is the responsibility of the contractor on site.**

### **STEP 1: GRAIN DIRECTION AND PREVENTATIVE MEASURES**

Because Acrovyn has a grain direction, all material should be installed with the same top and bottom orientation. To insure consistent orientation, always refer to the ink jet printed arrow on the reverse side of the sheet. Always install the sheet with the arrow in a consistent direction.

To ensure easy clean-up and / or prevent damage to adjacent finished, provide a drop cloth at the base of the walls, mask door and window frame edges, and remove all cover plates like switches, outlets and thermostat covers.

Acrovyn by Design<sup>®</sup> - In order to maintain pattern alignment and ensure layout, it is important to dry fit all sheets prior to installation. If installing custom designs, refer to drafting details for layout references.

### **STEP 2: WALL PRIMING**

New drywall or plaster – Walls must be sealed / primed using primer.

Painted drywall or plaster – Painted walls must be checked for adhesion as described under the wall preparation section. If the paint will not provide an acceptable base for adhesion, all areas must be removed and primed with primer.

Concrete, concrete block, wood paneling, plywood, particle board or similar – These surfaces must be made smooth with a coating of spackling compound and then primed with primer. CS suggests that all surfaces be checked for adhesion.

Flexible or rigid wall covering over drywall or plaster – Existing wall covering must be clean and their installation must be secure before installing Acrovyn wall covering. Priming is not necessary for these surfaces.

Acrovyn by Design<sup>®</sup> - Tinted primers can be used at sheet seam locations to match the graphic colors. Doing this in conjunction with applying clear caulk later could help make sheet joints less visible.

### **STEP 3: STARTING PROCEDURES**

Note: Bottom of sheet should be installed no less than 1" (25.4mm) recommended above finish floor for field variation.

Full height installation – Establish a plumb line to be located at the edge of the first sheet. This will serve as a starting point for the wall covering to be installed on that wall and will ensure the following sheets to be installed plumb. Establish a plumb line at the beginning of each new installation of wall covering.

Wainscot installation – Establish a level line at the specified height for the entire length of the run. Install the wall covering by aligning the top edge with this line. A level line should be established for each new installation.

### **STEP 4: SHEET PREPARATION**

Prepare the first sheet by making any necessary cutouts or scribe the edge to fit the inside corner if applicable. Remember to allow a 1/16" gap around door and window frames, ceilings and baseboards. Use a straight edge to ensure neat cutouts.

Place the sheet with the smooth side up and wipe the sheet with a clean, damp cloth to remove any dust or dirt.

Acrovyn by Design® - Trimming of sheets, if required, should be done at the beginning and the end of a run only to ensure pattern alignment on standard patterns only. Custom images should be cut and trimmed as noted on the submittal and F&F drawings. All necessary cutouts should be performed as previously described in these instructions.

Acrovyn by Design® - Do not damage the back of the sheet as it could cause damage to the printed imagery.

#### **STEP 5: ADHESIVE APPLICATION**

Use the supplied 1/8" V-Notch trowel to apply Acrovyn Interiors Heavy Duty Water Based Mastic Adhesive to an area of the wall surface that can be completed within the cure time of the adhesive. The 1/8" V-Notch trowel must be used to maintain the warranty and fire rating by ensuring proper glue coverage. Make sure the entire area receives an even coat. **DO NOT ALLOW THE ADHESIVE TO OVER CURE!**

When applying the adhesive to the wall, the trowel must be held as close to perpendicular or 90 degrees to the wall as possible. Angles less than perpendicular reduce the amount of adhesive for proper installation and may result in delamination.

Be certain the trowel notches are cleaned regularly, allowing the notches to fill with dried adhesive will reduce the application, which will cause failures because of inadequate adhesive. The projected coverage using the 1/8" V-Notch trowel is 125 ft<sup>2</sup> / gal. Occasionally check the adhesive coverage to ensure the correct amount is being applied.

Under ideal conditions, the proper cure time of the adhesive should be approximately 30 minutes but could be up to 2 hours. However, this time will vary depending on temperature and relative humidity. The use of fans for air movement may help reduce the adhesive cure time. A dehumidifier may also be used in high humidity conditions to help reduce cure time. When applied, the adhesive is white and creamy. As it cures, the adhesive will become translucent and tacky. In a porous substrate application, it is best to install the wall covering when the adhesive has cured approximately 75% or when it becomes tack and does not transfer onto your finger.

Nonporous surfaces like metal, high-pressure laminate or vinyl will not absorb moisture from the adhesive, thus retarding its cure time. It is important that the adhesive is firm, yet pliable, to the touch and that it does not transfer onto your finger. If the wall covering is installed before the adhesive has reached this stage, the moisture released by the curing adhesive will become trapped and at elevated temperature the wall covering will bubble and / or delaminate.

Once the adhesive has cured properly, the wall covering can be installed.

#### **STEP 6: HANDLING AND INSTALLATION**

Careless handling of Acrovyn wall covering could result in damage and unrepairable "kink" marks. Damage is less likely to occur when using two people to move and position the sheets.

Align the edge of the wall covering with the plumb or level line established in step 3 and rub the wall covering along the edge no closer than 6" (152.4mm) from that edge (to allow for positioning of vertical trims). Continue this procedure over the full length of that edge of wall covering until it has been aligned. Lightly rub the rest of the wall covering until the rest of its area has made contact with the wall surface. Sheets can be repositioned as long as they are not pressed firmly into the mastic adhesive.

**IT IS IMPORTANT TO REMOVE ANY EXCESS ADHESIVE WITH SOAP AND WATER BEFORE IT CURES AND BECOMES MUCH MORE DIFFICULT TO REMOVE.**

#### **STEP 7: TRIM APPLICATION**

When required, install the vertical trim after the first sheet is in place but before the smoothing operation. It is necessary to notch the back of all vertical trims where they intersect the wainscot trim (included inside / outside corner, see page 5 for rabbet detail). Attach the trim to the edge of the abutting sheet and align with the edge of the previously installed sheet, making sure that the trim overlaps both installed sheet. **DO NOT INSTALL THE TRIM TIGHT AGAINST THE SHEET EDGE – ALLOW TOLERANCE TO ACCOMMODATE THERMAL MOVEMENT.** Use a roller to ensure the trim makes contact with the adhesive and wall surface.

Wainscot trim is installed much the same way as vertical trim.

**Note: Trims can be mitered in the corners if picture framing or if vertical and horizontal are intersecting.**

Acrovyn by Design® - Clear caulk is standard, but metal trims, standard color plastic trims and standard color caulk are available.

Hughesville, PA | 800.233.8493 | 570.546.5941  
Mississauga, ON | 888.895.8955 | 905.274.3611

[www.c-sgroup.com](http://www.c-sgroup.com)  
[IWPTechSupport@c-sgroup.com](mailto:IWPTechSupport@c-sgroup.com)

**STEP 8: SMOOTHING OPERATION**

Once the Acrovyn sheet has been aligned with the plumb line or adjacent sheet, use a roller to insure maximum contact with the CS Water Based Mastic Adhesive. With the roller, start in the middle of the sheet and work toward the top, bottom and edges using full width strokes in an arching motion. By smoothing the sheet, you will also be able to remove any trapped air pockets. Once completed, run the palm of your hand over the entire surface feeling for bubbles or loose areas. Repeat the smoothing process as necessary until the entire sheet makes full contact with the adhesive.

**STEP 9: ABUTTING SHEETS**

Vertical trims – When specified, install vertical trims as described in step 7. The next sheet should be installed by inserting the adjacent edge into the vertical trim that’s been installed previously. Insert the corner of the adjacent sheet into the vertical trim and gradually work along the length of the trim until the wall covering is in position.

**Note:** If using metal vertical trims, it is necessary to rabbet 5/32" (3.9mm) off the backside of the trim. See rabbet detail on page 5.

Butt joints – Butt joints should only be used in temperature controlled environments of 75°F +/- 5°F (24°C +/- 3°C) during and after the installation. If the temperature is expected to exceed these temperature, please refer to the thermal movement chart on page 2 of the Wall Covering Supplement document to determine the appropriate joint spacing.

Color matched caulk – CS has caulk that matches the specified sheet color and can be purchased separately for use at wall covering joints. When caulked joints are specified, a gap is required between sheets. Refer to the thermal movement chart on page 2 of the Wall Covering Supplement document to determine the appropriate gap width, **BUT DO NOT MAKE THE GAP LESS THAN 1/16" (1.6mm) WIDE.**

Before applying caulk, mask each edge of the joint with masking tape to protect the wall covering from excess caulk. Once the joints have been masked, apply a bead of the color matched caulk to the joint. Coverage equals 90 – 100 feet per tube. Wait 4 hours before removing the tape.

In certain applications a second coat may be required. Please follow the same installation procedure when applying the second coat. Allow a minimum of 4 hours to cure before applying the second top coat.

**STEP 10: CORNER CONDITIONS**

At inside and outside corners, cut the Acrovyn wall covering to correct width minus 1/16" (1.6mm) to facilitate the installation of the inside or outside corner trim. Dry fit the sheet with the trim attached to ensure proper alignment or fit. Once satisfied with the fit, apply the adhesive as noted in step 5. Align the sheet edge with the adjacent piece and roll it toward the inside or outside corner.

**Note:** It is necessary to notch the back of the corner trim where it intersects the wainscot trim.

**STEP 11: CLEAN UP**

Upon completion of the installation, remove all protective materials (masking tape, etc.) except for the drop cloths. Inspect all joints and cutouts to ensure that all excess adhesive has been removed. Use soap and water to clean any areas that may have adhesive residue. Once the inspection and cleanup have been completed, the drop cloths can be removed and the cover plates and other wall-mounted items can be installed.

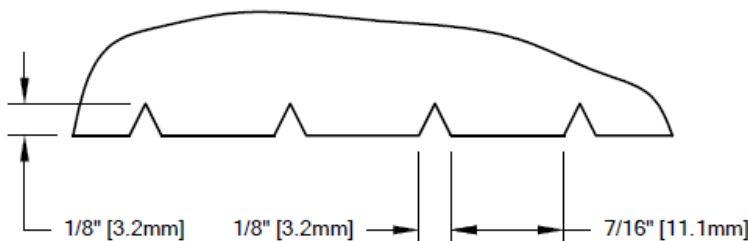

**Trowel Details**

Special 1/8" V-Notch trowel for use with Acrovyn wall covering.

Projected adhesive coverage using this trowel is 125 square feet / gallon. **DO NOT SUBSTITUTE!**

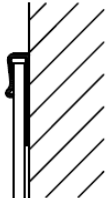

Wainscot Trim

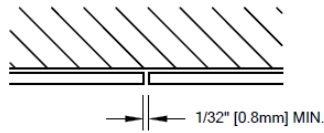

Standard Vertical Joint  
Refer to thermal movement chart for proper spacing

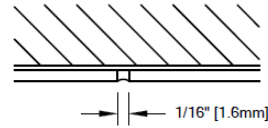

Optional Joint Color Matched Caulk

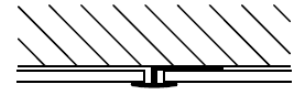

Optional Joint Vertical Trim

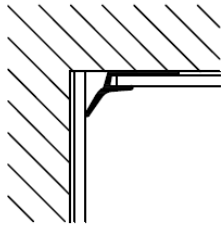

Inside Corner Trim

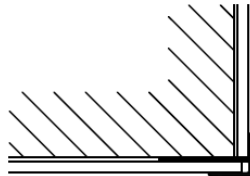

Standard Outside Corner Trim

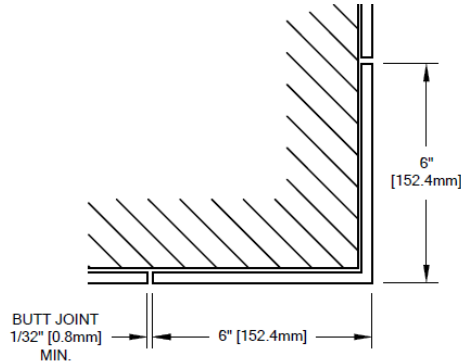

Formed Outside Corner Trim

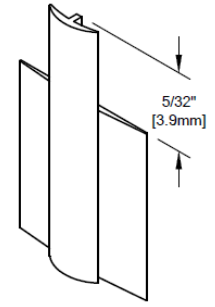

Rabbet Detail  
Metal vertical trim shown.  
Metal inside / outside corner trims also to be rabbeted

**ACROVYN TRIMS**

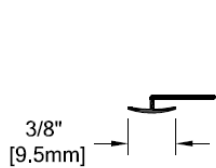

Vertical Trim  
(25N033xxxS, for .040/.060" sheet)  
(25N038xxxS, for .075" sheet)

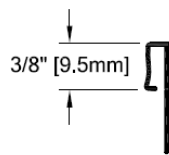

Wainscot Trim  
(25N036xxxS, for .040/.060" sheet)  
(25N040xxxS, for .075" sheet)

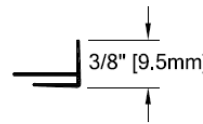

Outside Corner Trim  
(25N032xxxS, for .040/.060" sheet)  
(25N037xxxS, for .075" sheet)

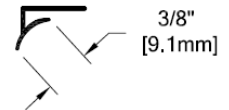

Inside Corner Trim  
(25N035xxxS, for .040/.060" sheet)  
(25N039xxxS, for .075" sheet)

**ALUMINUM TRIMS**

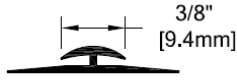

Vertical Trim  
(25A008001)

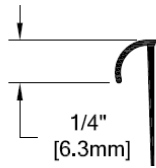

Wainscot Trim  
(25A011001)

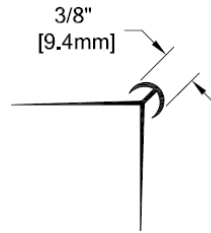

Outside Corner Trim  
(25A010001)

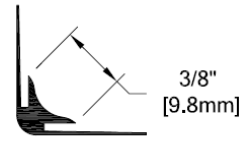

Inside Corner Trim  
(25A009001)

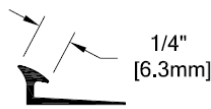

135° Outside Corner Trim  
(25A012001)

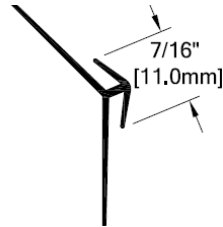

135° Outside Corner Trim  
(25A013001)

**NOTE:** Aluminum trims are only available for .040" and .060" sheet.